

# A Guide To TUTTI

This guide to TUTTI is intended to be an aide memoir to organisers who have never used TUTTI before and a refresher to those have. The guide contains:

1. The Kit Of Parts
2. Getting Started
3. Setting Up - Start & Finish Connections
4. Setting Up - Start & Finish Clocks
5. Judges
6. Testing Before Start
7. During And After The Event

## 1. The Kit Of Parts

A timer and telephone unit with:

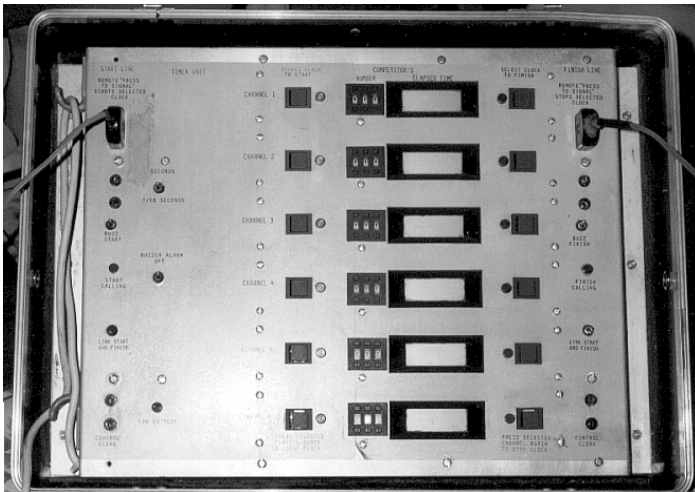

- Six timing channels, with 1 second or 1/10th second counting, selectable by switch, counting up to 9,999 seconds or 999.9 seconds respectively.
- Two telephone channels (Start & Finish) associated with the timer to enable remote start and stop of competitors; local start and stop at the TUTTI is also possible.

- Three telephone channels to enable 3 separate judging lines to be used; up to 5 judges, in press to speak mode can be placed on each judging line.
- Visual and audible facilities are available for signalling TUTTI to JUDGE and JUDGE to TUTTI.
- Low power consumption from a standard 12-volt car battery, with warning of low battery; proof against high and reverse battery.





# A Guide To TUTTI

## **1.1. Other Equipment You Will Also Need At Your Slalom: -**

- One box of BCU wire containing 18 wrappers, sufficient to provide communication links to a Starter and a Finisher and as many judging lines/judges as you require to adequately judge your course.
- Two boxes each containing 7 BCU Headsets and control boxes, which should cover small to medium sized events in providing one headset for each of the Control Staff Judges, Starters and Finisher, and still leave a few for spares. For further boxes of Headsets refer to the TUTTI Hiring Officer.

## **1.2. Other Equipment The Organising Club Needs to Provide: -**

- A 12 Volt Car Battery (or batteries if the timer and telephone are to be used in different locations), in good condition, which should last a full weekend. TUTTI will Flash and Bleep uncontrollably if it is below par! TUTTI will refuse to operate on 24 Volt PA supplies.
- Can of WD40 in case the weather is wet for spraying connecting plugs.
- Insulation tape in case wires get trodden on and damaged/broken.



# A Guide To TUTTI

## **2. GETTING STARTED**

You have probably already noticed that the case falls apart at the hinges! This allows the Timer and Judges telephones to be in separate areas if you wish; separate 12 volt batteries would then be needed. The battery lead for each half of TUTTI is wrapped around a clip in the left hand recessed compartment.

Connect the RED clip to the positive (+) terminal on your 12 volt Car Battery; DO NOT use whilst still attached to your car! **(Don't worry if you get the battery clips the wrong way round, TUTTI just won't work).**

If you connect TUTTI to a P.A. 24 Volt system it won't work, and probably not on a 12 volt battery whilst on charge!

If TUTTI starts to bleep uncontrollably – then sorry the battery is flat you will have to go and look for a new one! If both halves of TUTTI are in the same area, they can both be fed from the same battery.

The total power is small enough such that an average battery should easily last a whole weekend.

In fact, TUTTI will work quite happily with battery volts of 11 V to 15V. (If there is a Headset plugged into every line connector, then typically the judging half takes about 0.4 Amp and the timing half about 0.3 Amp).

All you need now is to get hold of "bodies" to operate TUTTI. Ideally:

- Two as judging clerks + two for relief
- One for Start & Finish clocks + one for relief
- One for results cards + one for relief

### **MOST IMPORTANT**

Practice with them some days before the event, not 5 minutes before the start time!

### **2.1. SETTING UP**

Putting out lines: -

Always start reeling out from TUTTI, leave plenty of spare wire in control for changes of position!

Set the TUTTI line's BUZZ SWITCH on, then if you carry a headset box with you as you reel out, you can check that the line is OK by plugging the box into each reel; it should BUZZ!

When you join on a new reel, always tie the new cable to the old reel first before plugging in, to keep strain off the plugs. Always keep wires and reels away from paths, dig in the wires or put it up in trees, keep the reel off the ground to avoid it being kept continuously wet.

When you have put all the wires out test for speech back to control using one clerk, with all lines COMMON SWITCH on to join them together. Don't forget to finally isolate the lines with the switch off to make sure that the correct clerks and judges are connected together.



# A Guide To TUTTI

## 3. Setting Up – Start & Finish Connections On The Telephone Unit

**N.B. Start and Finish circuits are a mirror image of each other.**

The start and finish line circuits of the timer half of TUTTI look like judges lines, but the internal connections are different!

Switching this toggle towards the bottom of the timer will cut off all speech and make the remote starter or finisher's box buzz. In this event, start and finish running times will be interrupted.

**Buzz Switch  
(Start & Finish)**

**Signal lamp  
(Start & Finish)**

If this toggle switch is pointing towards the bottom of the timer, the start and finish lines are joined together. The Starter & Finisher will be able to talk to each other. A three way conversation is possible between Starter, Finisher and Control Clerk.

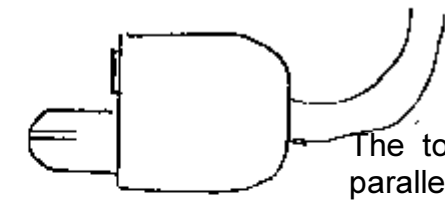

Connect the Start or Finish Line here

The top two sockets are in parallel....

A second headset can be put into the second socket to monitor without interfering with the use of remote buttons!

This lamp glows when the remote Starter or Finisher is using his/her button to start or stop. He/she must have the toggle switch set to OWN LINE on the headset control box!

**Common Switch  
(Link Start & Finish)**

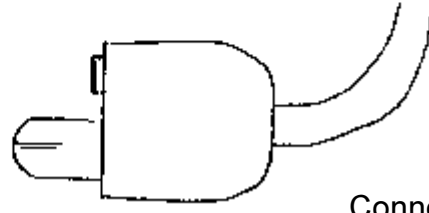

Connect Control Clerk's headset here.



# A Guide To TUTTI

## 4. Setting Up – Start & Finish Clocks On The Timer Unit

Green lamp glows when this clock is selected and flashes if the clock is started.

Red lamp glows when this clock is selected and flashes if the clock is running.

Pressing a Green button arms the next clock.

N.B. If the button is pressed when the lamp glows, indicating that it is already selected, the clock will start counting from "000"!

If the Starter has his/her headset set to OWN LINE mode, then pressing the headset box button "Press to Signal/Speak" will start the selected channel.

**Any previous time will be automatically lost.**

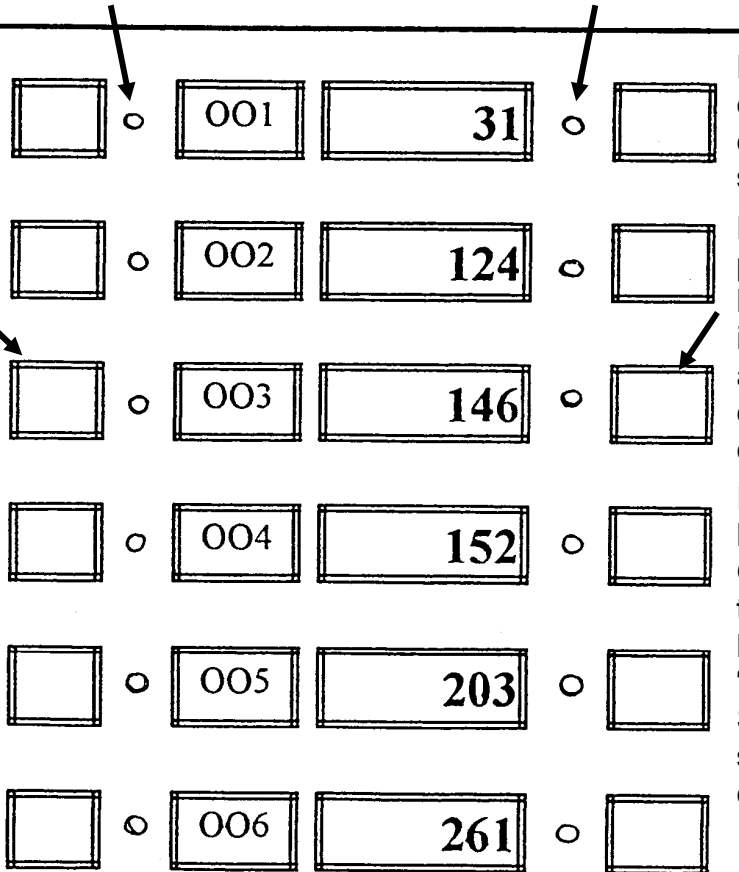

Pressing a Red channel button changes the clock selection.

N.B. If the button is pressed when the lamp glows, indicating that it is already selected, the clock will stop counting!

If the Finisher has his/her headset set to OWN LINE mode, then pressing the headset box button "Press to Signal/Speak" will stop the selected channel.

Manual counter to indicate competitor bib number

Displays time elapsed since start



# A Guide To TUTTI

## 5. Judges

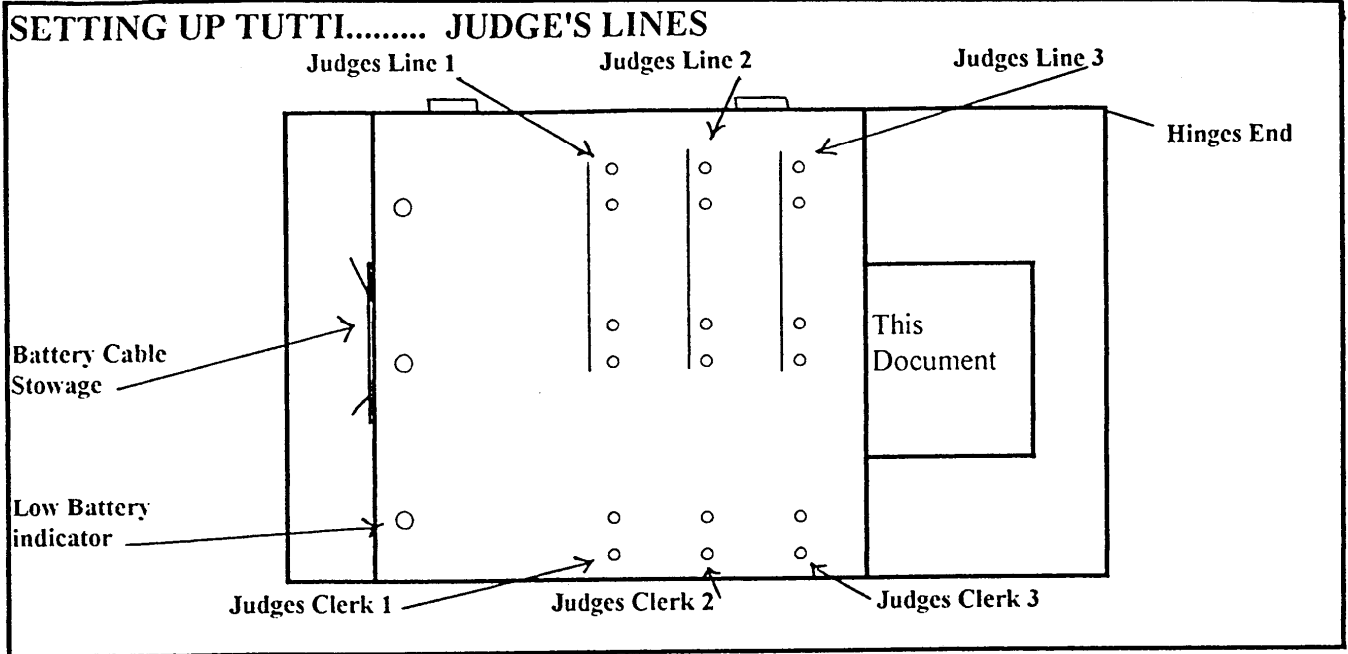

### Judges Line

Switching this toggle towards the bottom of the Judging Console will cut off all speech and make the remote judges boxes headset boxes BUZZ.

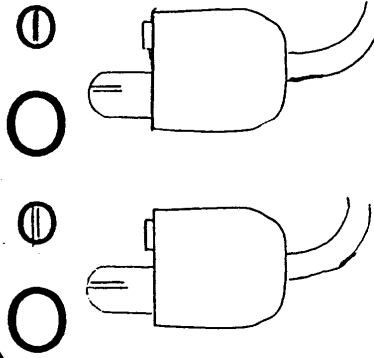

Connect the judging lines here.

The top two sockets are in parallel.

If the course is divided into two halves, both halves could be connected into the same circuit, or one socket could be used for monitoring.

Buzz Judges Switch

Judges Calling lamp

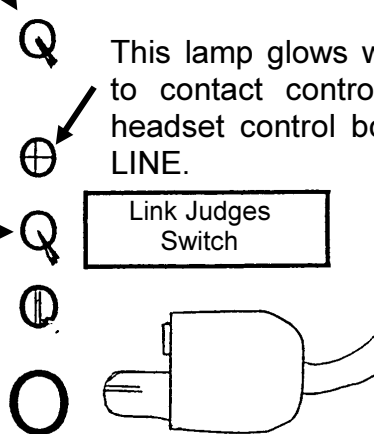

This lamp glows when a remote judge is trying to contact control. Judge must have his/her headset control box toggle switch set to OWN LINE.

Link Judges Switch

Switching this toggle switch towards the bottom of the Judging Console on any number of lines will connect the circuits together and the judges and clerk(s) will be able to hear and talk together.

Connect Judging Clerk's headset here.



# A Guide To TUTTI

## 6. TESTING THE EQUIPMENT

Always **before the event!!!!**

Plug each headset into its control box and then into one of the judging lines, note that setting the BUZZ JUDGES SWITCH on Telephone Unit to ON causes the box to buzz; with the headset box set to "OWN LINE" mode, depress the box's button and note that the lamp on Telephone Unit flashes. Note that you can hear yourself talking via the headset earphones, switch the box to "SHARED LINE" mode and note that your voice is only heard whilst holding the button pressed. Using the same method now put each of the wire reels in turn in series with the line headset. If the calling lamp comes on immediately there is a short in the reel somewhere. If buzzing occurs with the BUZZ JUDGES SWITCH off, the line has a reversal in it. Usually it is the free end that needs reversing, but check both plugs on the reel make sure that it is not one of them! if no buzzing occurs, set the BUZZ JUDGES SWITCH on, a buzz should now occur, if not the line is open circuit.

To help with fault finding in the field it is useful to mark each reel, and its free plug, with a suitable line code A1, A2 etc. on PVC Tape only please.



# A Guide To TUTTI

## **7. During And After The Event**

Once all the equipment has been “bench” tested, installation in the field should be straightforward. When all the equipment is in place, carry out a check back to control (with a tested and proven headset and box). This requires an assistant in control whilst connections are tested along the course.

Once the event has started, the equipment should need no attention or maintenance.

Once the event has finished for the day it is important to disconnect the headset from the headset box and the box from the cable. It should be noted that located in each headset box is a rechargeable battery (charged normally from the system when connected to a 12v battery), if disconnection is not performed, and the 12v battery disconnected at control, the internal battery will discharge. This will give rise to problems for the following day or perhaps more importantly, the next organiser!

### ***7.1. Hints And Tips***

- 7.1.1. In the event that a box or boxes have been left connected and the internal battery discharged, the wearer of the headset will hear a dull buzzing. This box may not be faulty, but may need charging. Plug it into the system somewhere and allow the battery to re-charge.
- 7.1.2. In the event that many boxes seem to be faulty, indicating that the previous organiser has been negligent, bench assemble the whole system and leave it connected to a 12v battery for 3 or 4 hours. If this does not resolve the problem, call the TUTTI maintenance officer named in the yearbook, before the event, not just before it is due to start.
- 7.1.3. Once the equipment is out of its boxes, store the boxes in a dry place, or at least with the lids secure, ingress of moisture can affect the operation for the next organiser.
- 7.1.4. When the event is finished: -
  - 7.1.4.1. Remove any tape, labels or other indications other than indications of faulty equipment.
  - 7.1.4.2. Re box in a tidy fashion.
  - 7.1.4.3. If equipment has got wet, and time allows, leave the box lids off slightly to allow time for drying until the set is collected from the next organiser.
  - 7.1.4.4. Report any faulty, damaged or lost equipment immediately to the TUTTI maintenance officer!
  - 7.1.4.5. Pass on the equipment in the state you hope to receive it.